

C4 MKII

Battery Based Actuator
Control System



The C4 system is a versatile solution for the control of electric actuators. The unique design, strong power supply system and the option of controlling multiple actuators make the C4 system ideal for use in various applications. Certified to medical standard (IEC60601-1).

The C4 system consists of:

- Controller
- Handset
- Battery
- Battery charger

The C4 solution is designed for optimal flexibility making configuration, programming and installation very easy. Additionally, service and replacement of e.g. batteries are extremely easy with the patented magnetic principle. No tools are required.

The C4 Controller is designed to handle up to four actuators in groups, synchronous or individually. It is controlled with a wired handset, which can be delivered in five different button layouts depending on customer needs. Furthermore, the C4 can be equipped with an external emergency stop.

The C4 system contains a rechargeable 24 VDC NiMH battery, enabling the actuator solution to be fully mobile.

Standard C4 solution includes IP50 protection with IP65 protection available.

This datasheet is related to C4 firmware version 662 (v662) only.



Associated software (version 3.10) can be found here:
<https://www.concens.com/information/downloads/#software>

Features

- Intuitive and more advanced software for pc-programming
- 4-channel fully programmable controller
- Battery powered for mobile use
- 24 VDC NiMH replaceable battery
- Patented battery system
- Customized colors and foil design
- Wired handset
- Adjustable soft- start and stop
- Adjustable current limit in and out
- Adjustable calibration speed and current
- Adjustable virtual min/max-position
- Individual or synchronous operation for drive 2 - 3 - 4 or 2 + 2 actuator
- Audible and visual status signal

Technical Data

Supply	24 VDC NiMH battery
Idle current	< 5 mA
Current limit	8 A/ch max. total 12 A
Current trip delay	30 ms
Ramps	0 - 3 sec
Operating temp.	5 ... 40 °C
Connector type	Molex Mini-Fit 6 pin
Weight Controller	430 g
NiMH Battery Charger	430 g
Battery	530 g
Battery Capacity	NiMH: 1400 mAh

C4-MKII

System Components

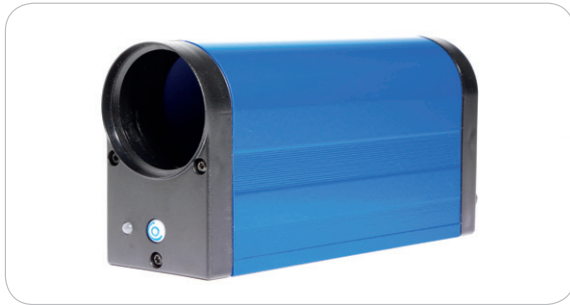

Controller



Brackets



Handsets



Customisable Foils



Battery Charger



Battery

Electrical Connections

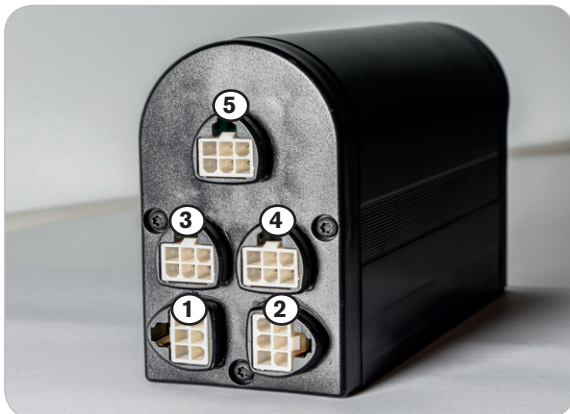

- ① Actuator 1
- ② Actuator 2
- ③ Actuator 3
- ④ Actuator 4
- ⑤ Handset,
External Power
Emergency Stop

C4-MKII

System Parameters

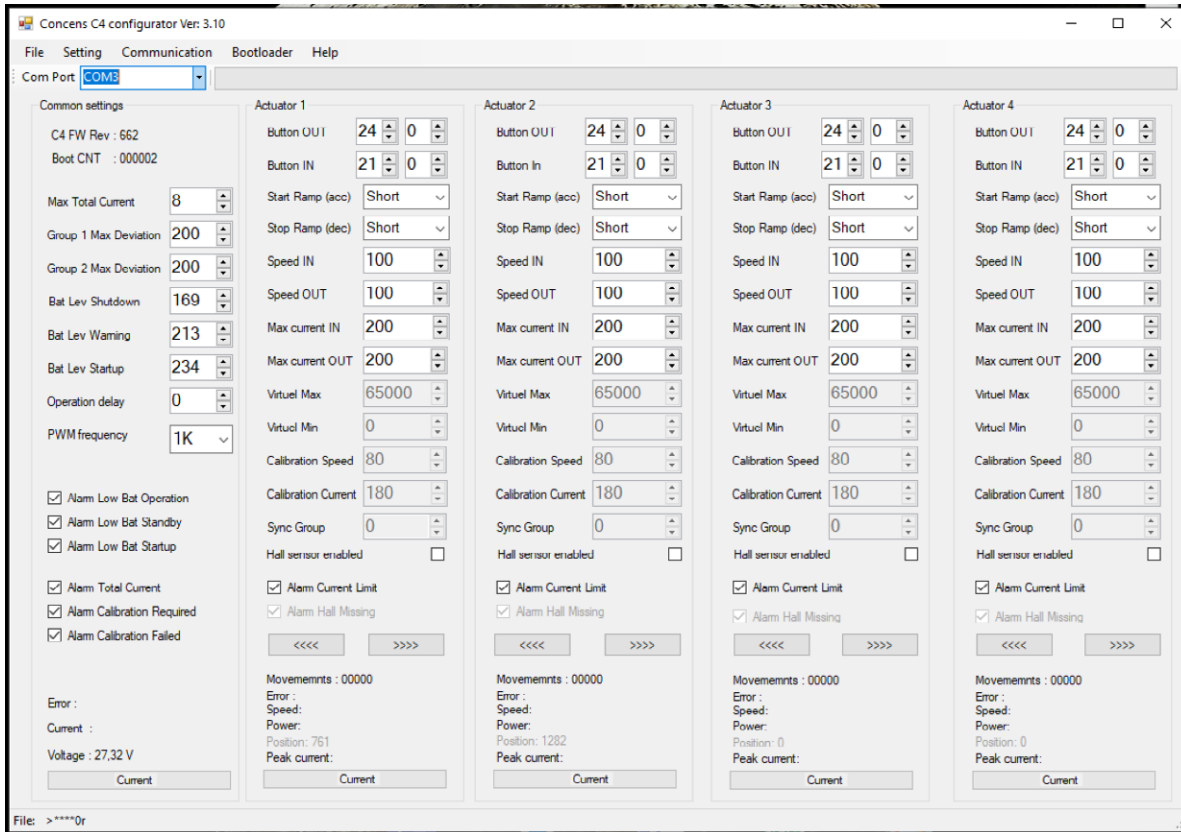

- Copy function of parameters from one channel to the next
- Selectable PWM frequency
- All alarms can change state “on” or “off” with regards to signals (beeps and blinking)
- Automatic COM port recognition
- Build-in Bootloader
- “Mouse-over” information

Mechanical Dimensions

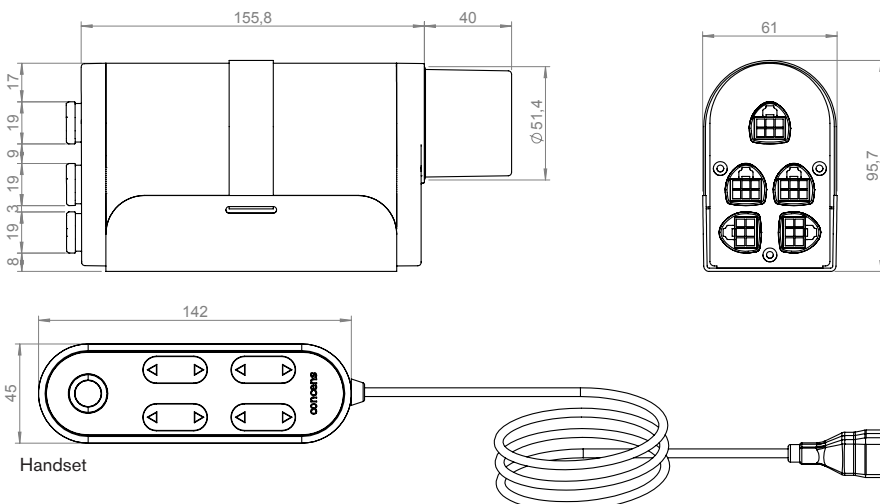

C4-MKII

C4 Item Number Combination

Controller

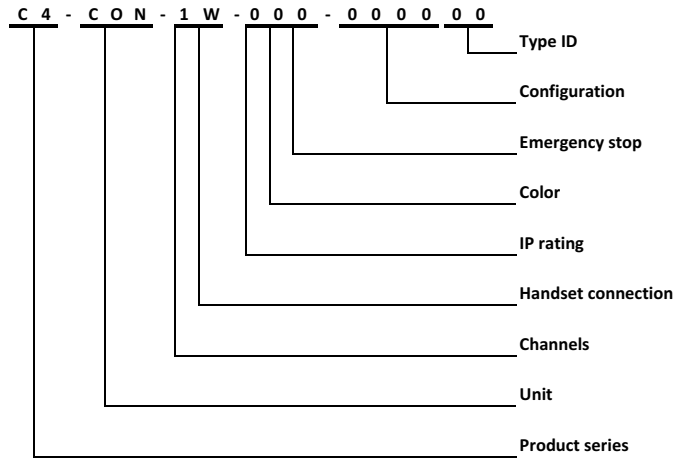

Handset

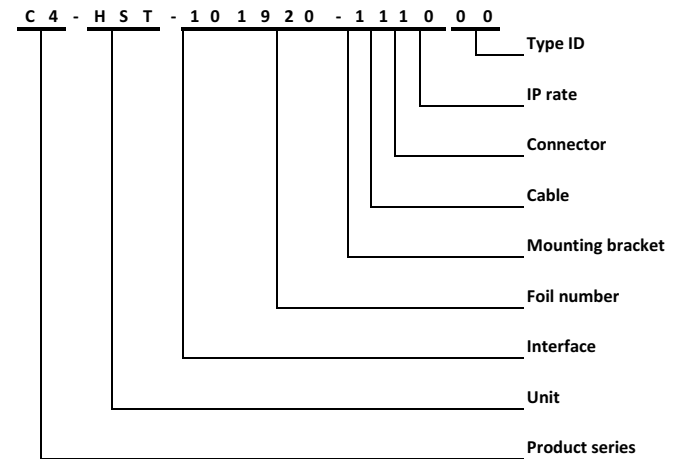

Supply

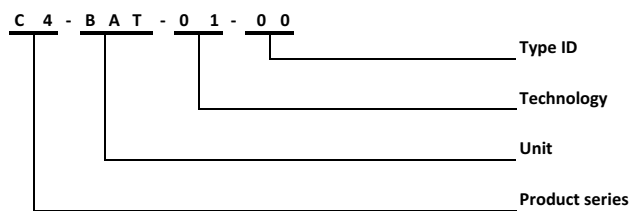

Charger

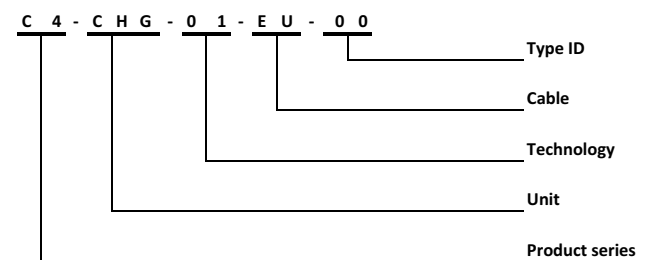

C4-MKII

C4 Accessories

- C4-PROG **Programming-cable for the C4 controller**
- C4-YCBL **Splitter-cable for the C4 controller**
- C4-YCBL-EMS **Splitter cable for “Emergency Stop”**
- C4-LOCK **Clip for securing the C4 controller in the mounting bracket.**

Recommendations and warnings

- If power is cut while actuators are travelling, the new position is not memorized. Hence calibration or learning must be performed to bring system back on track.
- To secure long lifetime of NiMH batteries, we strongly recommend to recharge the batteries at least every 3 months.

Disclaimer

- Concens products are continuously developed, built and tested for highest requirements and reliability but it is always the responsibility of the customer to validate and test the suitability of our products in a given application and environment. Concens products must not be used in safety critical applications.
- We do our utmost to provide accurate and up-to-date information at all times. In spite of that, Concens cannot be held responsible for any errors in the documentation. Specifications are subject to change without prior notice.

For more information, please visit our website at www.concens.com

