

concens® 

Preferred Partner for
**CUSTOMISED
ACTUATOR
SOLUTIONS**



FLEXIBLE STANDARD CONFIGURATIONS

All products are designed in standard configurations that cover practically any requirements in a variety of industries.



OR

DESIGN YOUR OWN ACTUATOR SOLUTION with "Cadenas" design tool

Your development team has access to our 3D Configurator Tool to improve built-in opportunities and facilities.



ACTUAL PROTOTYPE WITHIN
48
HOURS



DEDICATED TECHNICAL SUPPORT TEAM TO HELP YOU

You can benefit from our knowledge on industry standards and compliances when implementing actuator solutions.



COMPACT & SLIM DESIGN FOR EASY FITTING

We make it a top priority to produce designs that integrate our various products – actuators, controllers, battery-solutions and hand sets – into a unified, highly satisfying solution

Customised Design & Configuration for Your Application

Concens delivers solutions for applications in various industries:



rehab/medical



car adaptation

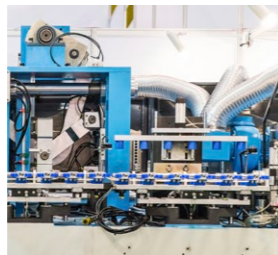

industrial automation



industry



building



agriculture

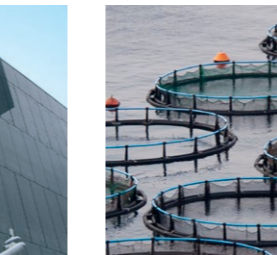

maritime/aquaculture



indoor living



special vehicles and more

Your individual needs are our success

We are dedicated in supplying high-quality actuators and controllers that will enhance and improve your solution in a variety of industries.



LOCAL PARTNERS & SUPPORT



For global partners visit www.concens.com



ACTUATORS con35, con50 & con60

The Concens actuator range differ in size and performance – from very slim & compact to heavy-duty application. All actuators can be configured according to colour, strength, dimensions and other parameters, and they are also available in specialised versions.

Ranged up to
10.000 N



Strong,
with up to...
**5 YEARS
WARRANTY**
on standard actuators



CONTROL SYSTEMS C1, C2-10/20/30 & C4

Our digitally programmable control systems for actuators allow advanced and extremely precise electronic control and protection of the actuator as well as the equipment that the actuator is connected to.



BATTERY SOLUTION & HANDSET FOR FULL MOBILITY

Several control systems can be equipped with battery solutions with NiMH Batteries or Li-Ion Batteries as well as a handset in standard and customised versions.



**CERTIFIED &
PATENTED
ACTUATORS &
CONTROLLERS**

Certification:
IEC/EN/UL60601-1

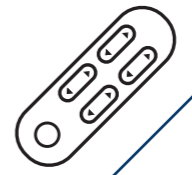

From One Actuator to Thousands...

Strong, Compact & Outstanding Design



SMALL OR LARGE QUANTITIES

Our flexible factory set-up allows us to produce large quantities of actuator solutions – even with quick delivery time!



For Product details visit
www.concens.com



SPECIALISTS IN ACTUATOR TECHNOLOGY

From the very start in 2003 the goal of Concens was to design and market state-of-the-art actuators in slim, compact, and strong designs, and thereby create new opportunities for individuals and companies to improve their value, quality and competencies.

FLEXIBLE & CUSTOMER-ORIENTED SET-UP

At Concens we are dedicated to being the preferred partner for companies looking for uncompromising design and outstanding value. We are not satisfied until your product or application with a Concens actuator solution is a success.

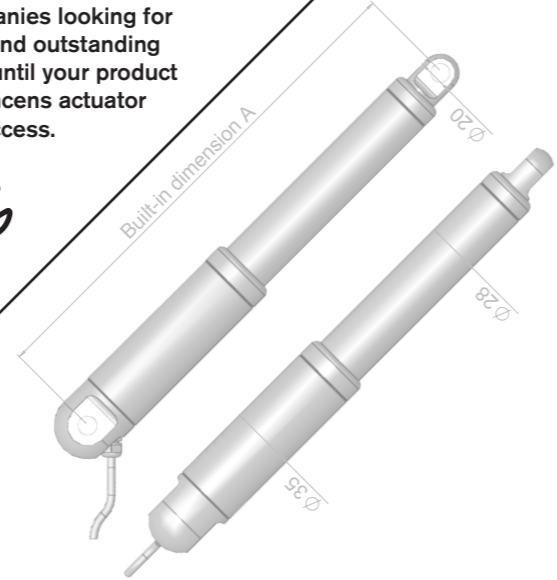

INNOVATION WITHIN ACTUATOR TECHNOLOGY

Concens is driven by strong values of commitment, versatility and flexibility. We aim to be at the forefront of developments within actuator technology in an ever-changing market as well as to combine design, size and functionality with customers' requirements. We are not satisfied until the tiniest detail is perfect, whilst maintaining a clear focus on the overall solution.

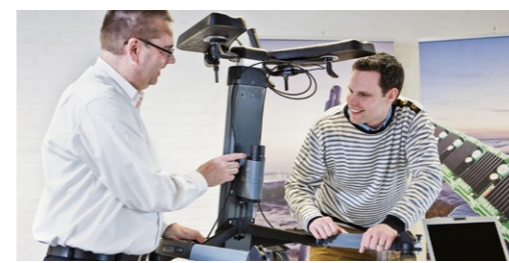
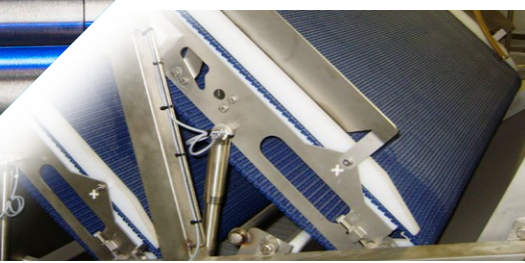

Our global partners are ready to help you with your actuator application

Driven by Innovation, Perfection & Dedication

An Experienced Partner - Worldwide

Concens is represented in several countries via partners. Outside these countries Concens handles projects directly from Denmark. If you require any further information about Concens or our products & services please visit our website or contact your local partner or the head office in Denmark.



concens 



Linked  in



 YouTube

Global Partners & Support

Our global partners are ready to help you with you actuator application, with prototypes, technical knowledge and a customer-oriented approach. For an updated list of our global partners please visit our website or use this QR code for a quick link.



Global Partners

concens

Concens A/S
Oddesundvej 1
DK-6715 Esbjerg N
Denmark

T +45 70 11 11 31
E info@concens.com
VAT DK10132266

www.concens.com