

Mounting brackets for i/con35

Part No. 35-230-01-0000-10-01

Front & Rear mounting brackets suitable for standard Concens actuator brackets. Material: Steel, electro galvanized.

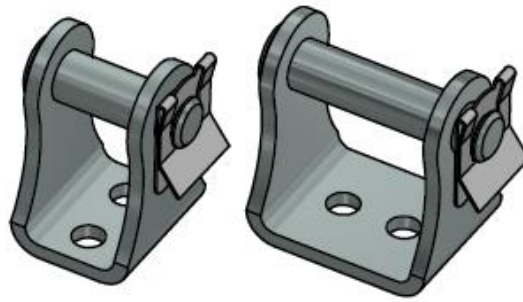

Dimensions mounting bracket i/con35: Front

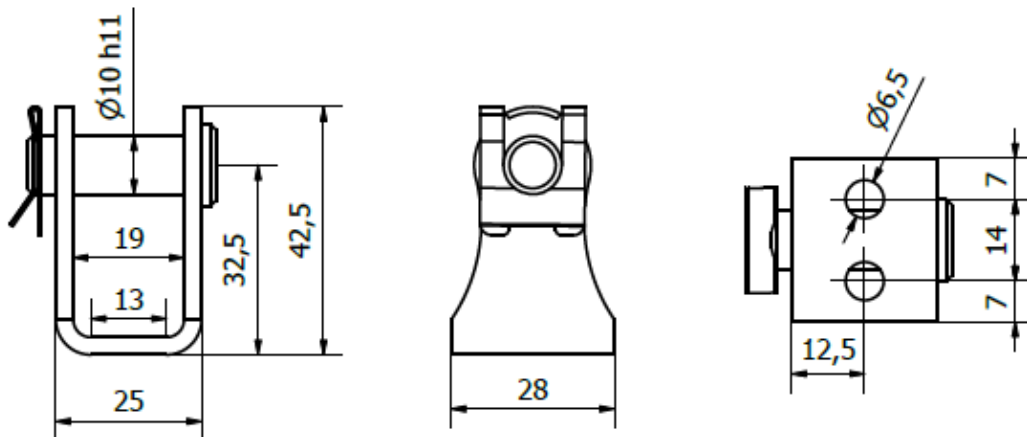

Dimensions mounting bracket i/con35: Rear

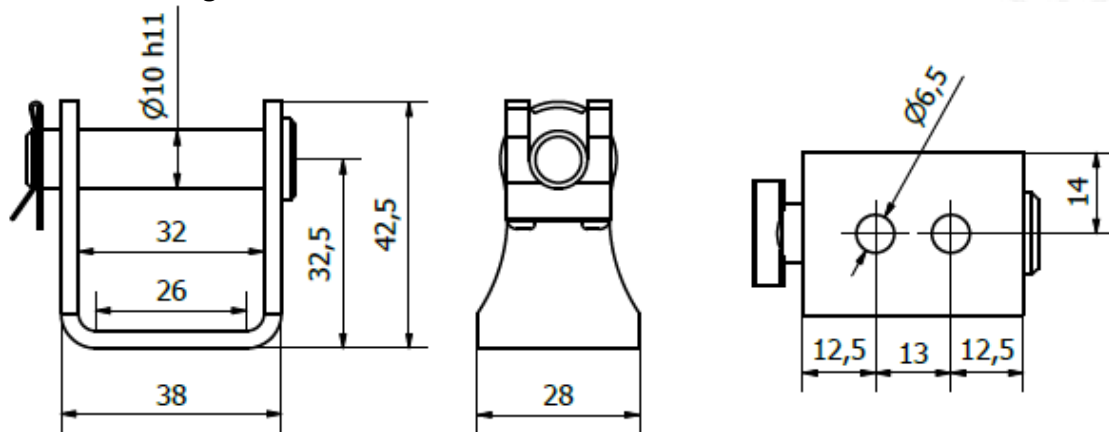

Recommendations:

- The mounting brackets are designed to be bolted to the desired application, but it is up to the customer to validate that the surface on which the brackets will be mounted to, is plain and constructed to withstand the additional loads.

Disclaimer:

- Concens products are continuously developed, built and tested for highest requirements and reliability but it is always the responsibility of the customer to validate and test the suitability of our products in a given application and environment. Concens products must not be used in safety critical applications. We do our utmost to provide accurate and up-to-date information at all times. In spite of that, Concens cannot be held responsible for any errors in the documentation. Specifications are subject to change without prior notice.

ONE-PAGER | Mounting Brackets i/con35 | March 2024 |

concens

Oddesundvej 1 | DK-6715 Esbjerg N | Denmark
+45 7011 1131 | info@concens.com | VAT: DK10132266

WWW.CONCENS.COM

EXCELLENT ELECTRIC ACTUATORS.