

# Mounting brackets for con50

Part No. 50-230-01-0000-10-01

Front & Rear mounting brackets suitable for standard Concens actuator brackets. Material: Steel, electro galvanized.

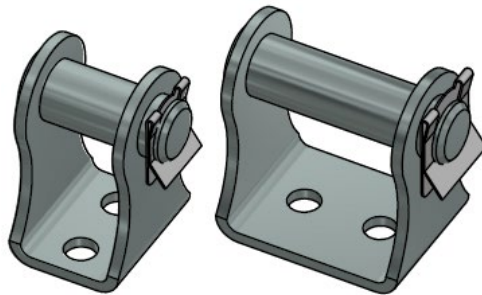

Dimensions mounting bracket con50: Front

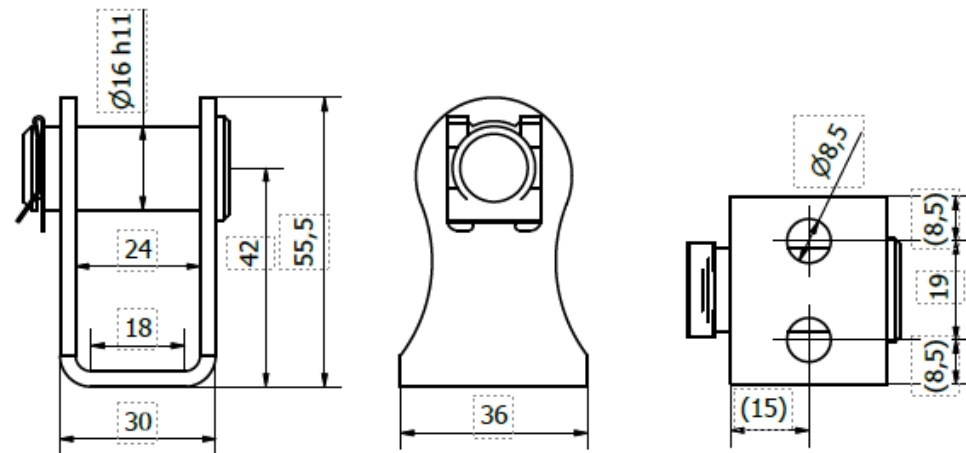

Dimensions mounting bracket con50: Rear

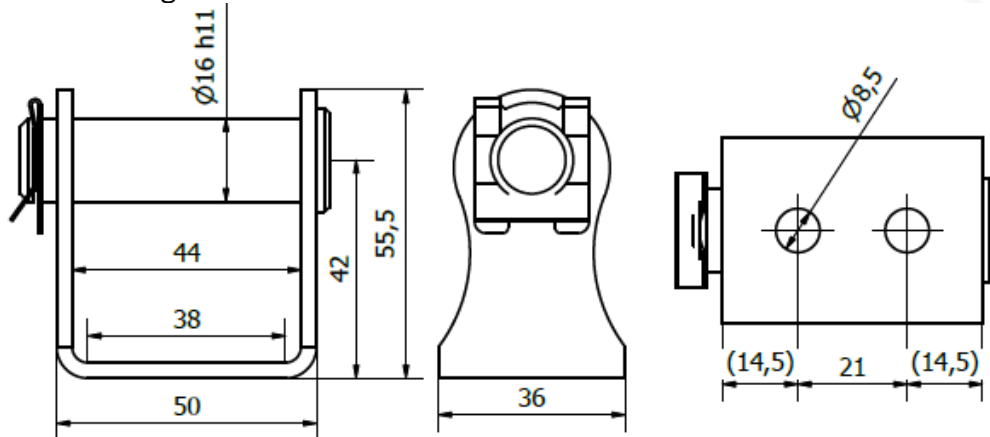

## Recommendations:

- The mounting brackets are designed to be bolted to the desired application, but it is up to the customer to validate that the surface on which the brackets will be mounted to, is plain and constructed to withstand the additional loads.

## Disclaimer:

- Concens products are continuously developed, built and tested for highest requirements and reliability but it is always the responsibility of the customer to validate and test the suitability of our products in a given application and environment. Concens products must not be used in safety critical applications. We do our utmost to provide accurate and up-to-date information at all times. In spite of that, Concens cannot be held responsible for any errors in the documentation. Specifications are subject to change without prior notice.

ONE-PAGER | Mounting Brackets con50 | October 2021 |

**concens**

Oddesundvej 1 | DK-6715 Esbjerg N | Denmark  
+45 7011 1131 | info@concens.com | VAT: DK10132266

W W W . C O N C E N S . C O M

EXCELLENT ELECTRIC ACTUATORS.